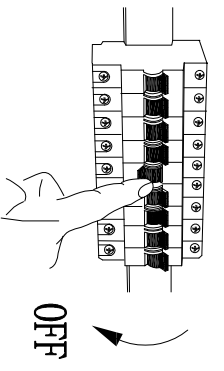
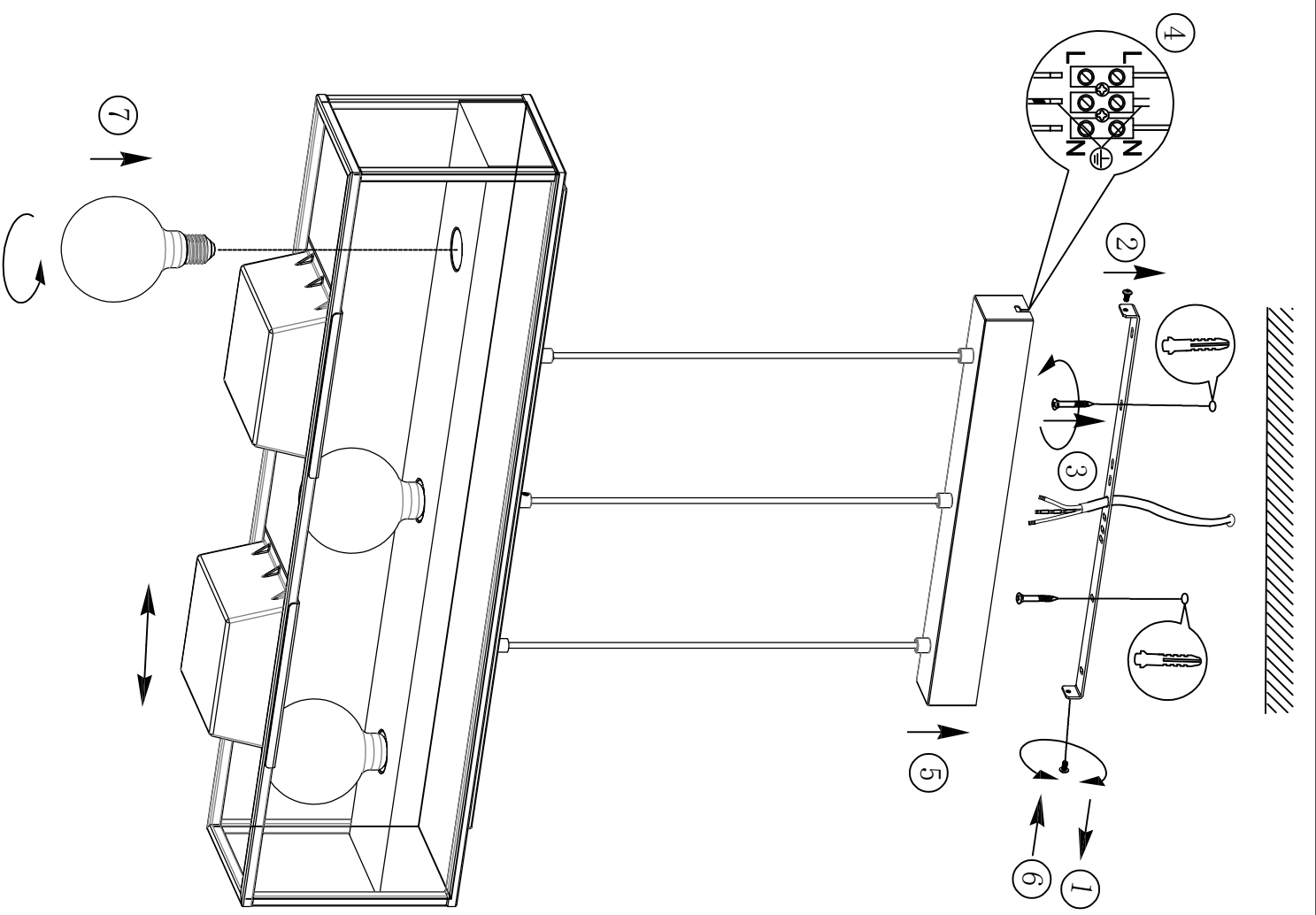
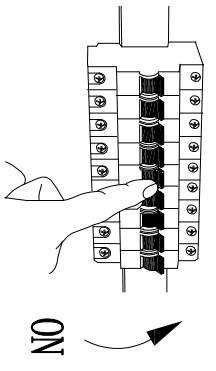

A**B****C**

B900349
www.eglo.com